

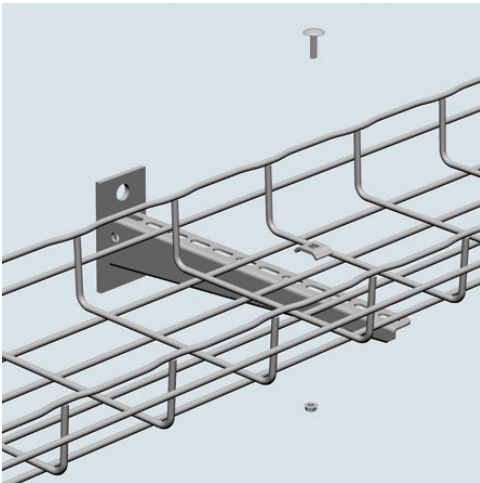

Cablofil
REINFORCED WALL BRACKET-HOT DIPPED (2D,,2W,,24L) [557273]
Part No. 557273



Cablofil Wiremesh Cable Tray concept based upon performance, safety and economy; three qualities which make Cablofil Wiremesh Cable Tray system preferred by installers. Cablofil adapts to the most complex configurations, and its structure gives maximum strength for minimum weight. The ease of creating fittings, carried out on site, as well as the wide range of unique and universal accessories gives complete freedom in routing combined with exceptionally fast installation.

Features & Benefits

Hot dipped galvanized after fabricated for corrosion resistance.CE25 and EZBN 1/4 are sold separately.

Specifications

General Info

Product Line	Cablofil	Finish	Hot Dipped Galvanized
UPC Number	800388003071	Country Of Origin	France
Type	Supports		

Dimensions

Product Width US	1.969 in	Product Weight US	2.582 lb
Product Volume US	0.132 cu ft	Product Depth US	24.31 in
Product Height US	4.77 in		

Buy American Act Compliance

BAA	Yes
-----	-----

Additional Information

RoHS Conformant	Yes	Product Environmental Profile	Yes
-----------------	-----	-------------------------------	-----