

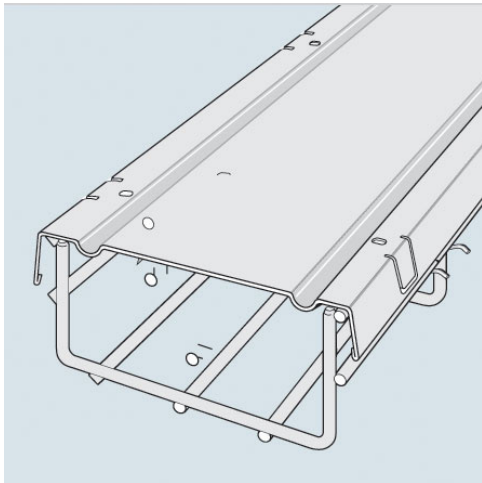

Cablofil
CABLOFIL COVER-HOT DIPPED (3 PCS) (8W) [629203]
Part No. 629203



Cablofil Wiremesh Cable Tray concept based upon performance, safety and economy; three qualities which make Cablofil Wiremesh Cable Tray system preferred by installers. Cablofil adapts to the most complex configurations, and its structure gives maximum strength for minimum weight. The ease of creating fittings, carried out on site, as well as the wide range of unique and universal accessories gives complete freedom in routing combined with exceptionally fast installation.

Features & Benefits

Cover eliminates dirt and dust build-up on cable. Field fabricate on-site to fit changes in levels. Use built-in tabs for permanent attachment to tray. 3- 3.3' covers are included in each package to cover 1-10' section of tray.

Specifications

General Info

Product Line	Cablofil	Finish	Hot Dipped Galvanized
UPC Number	800388004603	Country Of Origin	Italy
Type	Straight Sections		

Dimensions

Product Width US	9.25 in	Product Weight US	9.19 lb
Product Volume US	0.211 cu ft	Product Depth US	39.5 in
Product Height US	1.0 in		

Buy American Act Compliance

BAA	Yes
-----	-----

Additional Information

RoHS Conformant	Yes
-----------------	-----