

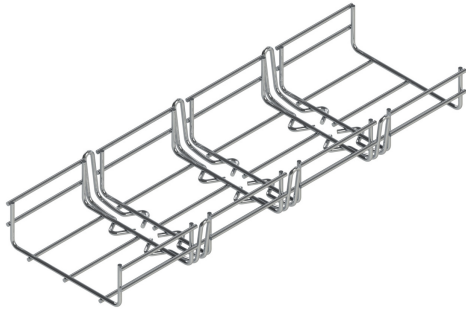

Cablofil  
CabloBend54/150EZ  
Part No. 945460



Every data center requires numerous cable tray bends and drops—sometimes thousands in just one installation. With traditional cutting and bending, each drop can take over four hours to complete. With Cablobend Systems, you have the freedom to flexibly create the bends and drops that you need. No more cutting unless shortening the length.

## Features & Benefits

Adjustable mesh tray fitting.

Shrink your installation time to just minutes per bend with zero cutting required on thousands of bends in a single project.

Available in three heights (2", 4" and 6"), five widths (6", 8", 12", 18" and 24") and two finishes (EZ and BL).

Rigidity clips included to fasten sections together for added strength depending on your needs.

Easy-to-bend flex wires. The quickest up-and-down bends in the industry.

Wide range of adjustability. Vertical and horizontal angle adjustability to 90° to fit any configuration.

Safer installation, no need for cutting tools and less time on elevated areas for installation.

Pre-made and pre-assembled for increased prefab efficiency.

## Specifications

### General Info

Product Line	Cablofil	Color	Silver
Finish	Electrozinc	UPC Number	800388484467
Country Of Origin	United States	Application Sector	Commercial/Industrial

### Dimensions

Product Width US	6.0 in	Product Weight US	1.59 lb
Product Volume US	0.278 cu ft	Product Depth US	18.0 in
Product Height US	2.0 in		

---

## Listing Agencies / 3rd Party Agencies

---

cULus Listed                      Yes

---

## Buy American Act Compliance

---

BAA                                      Yes                                      TAA Compliant                      Yes

---

NAFTA                                      Yes

---

## Additional Information

---

RoHS Conformant                      Yes

---