

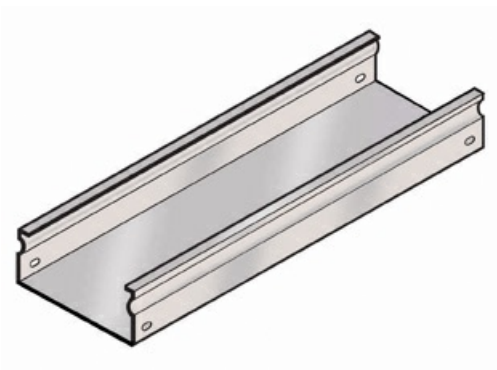

Cablofil  
**TROUGH - BLACK (2D,8W,120L)**  
Part No. 960002



Cablofil Fiber Trough utilizes high strength steel components to provide the strength and durability required to manage fiber cabling requirements in the most demanding data center environments.

## Features & Benefits

Strong corrosion resistant steel construction.

Rolled Edge: for cable protection.

Unique Design: allows cover to snap on.

18 gage steel (t).

## Specifications

### General Info

Product Line	Cablofil	Finish	Custom Painted
UPC Number	800388241992	Country Of Origin	Italy

### Dimensions

Product Width US	7.9 in	Product Weight US	11.7 lb
Product Volume US	1.075 cu ft	Product Depth US	117.6 in
Product Height US	2.0 in		

### Buy American Act Compliance

BAA	Yes
-----	-----