

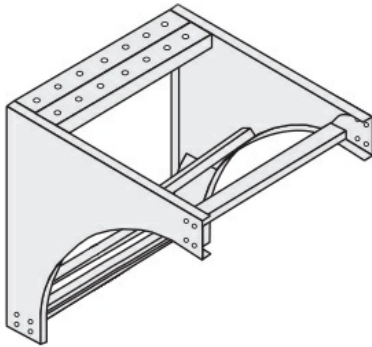

**Cablofil**  
**Vertical Support Elbow**  
Part No. P035524



Choose from an extensive selection of metallic ladder tray with a variety of rung and bottom styles to choose from. Finishes include steel, 304L and 316L stainless steel to meet the needs of any application. Rail heights range from 4" to 7" and width sizes are available up to 36".

## Features & Benefits

---

Splices included

## Specifications

---

### General Info

---

Product Line	Cablofil	Finish	GC
UPC Number	800388391666	Country Of Origin	Mexico

---

### Dimensions

---

Product Width US	9.0 in	Product Weight US	34.011 lb
Product Volume US	6.021 cu ft	Product Depth US	34.0 in
Product Height US	34.0 in		

---

### Buy American Act Compliance

---

BAA	Yes
-----	-----

---