

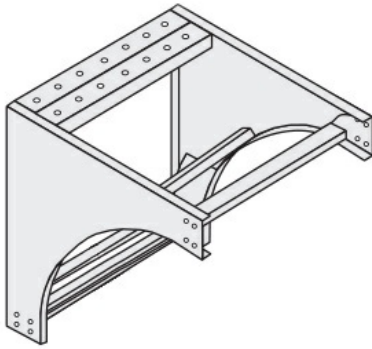

**Cablofil**  
**Vertical Support Elbow**  
Part No. P036372



Choose from an extensive selection of metallic ladder tray with a variety of rung and bottom styles to choose from. Finishes include steel, 304L and 316L stainless steel to meet the needs of any application. Rail heights range from 4" to 7" and width sizes are available up to 36".

## Features & Benefits

---

Splices included

## Specifications

---

### General Info

---

Product Line	Cablofil	Finish	GC
UPC Number	800388409781	Country Of Origin	Mexico

---

### Dimensions

---

Product Width US	12.0 in	Product Weight US	59.071 lb
Product Volume US	16.0 cu ft	Product Depth US	48.0 in
Product Height US	48.0 in		

---

### Buy American Act Compliance

---

BAA	Yes
-----	-----

---