

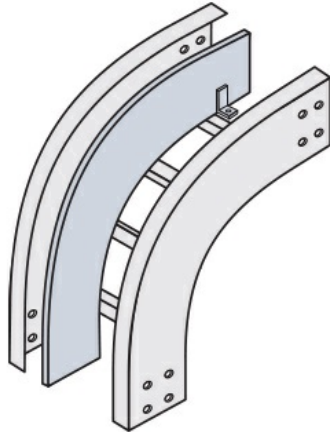

**Cablofil**  
**Discontinued - Vertical Fitting Divider**  
Part No. P087749



"The aluminum I-beam design of ITray is perfect for industrial installations with large diameter cables in long span situations, minimizing total tray width and creating a smooth transition between straight sections and fittings. A structural offset in the sidewall creates strong, mid-span splices that need fewer supports. Each splice snaps in place and stays without holding. Additionally, only four bolts are needed for each splice reducing hardware needs by 50%. These features allow Itray to be installed up to 30% faster than standard tray."

## Features & Benefits

Designed to fit the exact radius of the fitting

## Specifications

### General Info

Product Line	Cablofil	Finish	Pre-Galvanized
UPC Number	800388518193	Country Of Origin	Mexico

### Dimensions

Product Width US	1.063 in	Product Weight US	3.71 lb
Product Volume US	0.318 cu ft	Product Depth US	22.75 in
Product Height US	22.75 in		

### Buy American Act Compliance

BAA	Yes
-----	-----