

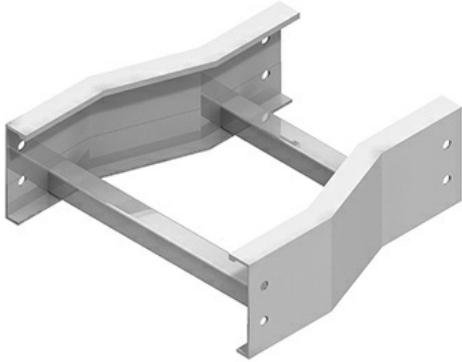

Cablofil  
**SB-7A-SR18-12 AL 7H STR REDUCER 18/12W**  
Part No. P320448



The aluminum I-beam design of ITray is perfect for industrial installations with large diameter cables in long span situations, minimizing total tray width and creating a smooth transition between straight sections and fittings. A structural offset in the sidewall creates strong, mid-span splices that need fewer supports. Each splice snaps in place and stays without holding. Additionally, only four bolts are needed for each splice reducing hardware needs by 50%. These features allow Itray to be installed up to 30% faster than standard tray.

## Features & Benefits

Material: Aluminum Alloy 6063

Bottom: LD: 1" wide rung

Connectors: All fittings are supplied with

Finish: Plain

Construction: Welded

Fitting heights (H): 4, 5, 6, 7

## Specifications

### General Info

Product Line	Cablofil	Finish	AL
UPC Number	800388196223	Country Of Origin	Mexico

### Dimensions

Product Width US	19.5 in	Product Weight US	5.362 lb
Product Volume US	1.471 cu ft	Product Depth US	18.0 in
Product Height US	7.241 in		

### Buy American Act Compliance

BAA	Yes
-----	-----