

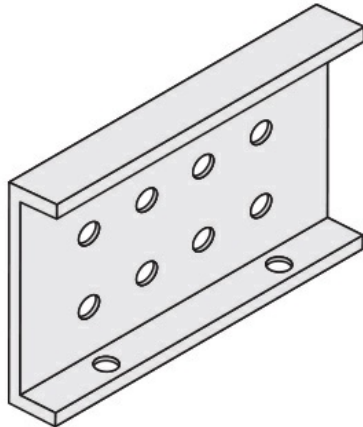

Cablofil
Mid-Span Splice Plate
Part No. P642820



Finishes include steel and 316L stainless steel to meet the needs of any application. Rail heights range from 4" to 7".

Features & Benefits

All splices are supplied in pairs.

Geomet fasteners are standard on aluminum and steel cable tray systems.

Type 316 stainless steel fasteners are standard on stainless steel systems, but are available as an option on all aluminum and steel systems.

Sufficient connector pairs with fasteners are automatically included with each shipment of straight sections and fittings. Extras for field cuts or spares must be ordered separately.

Bonding jumpers are required for all expansion splice plates, adjustable connectors, and tray discontinuities.

Specifications

General Info

| | | | |
|--------------|--------------|-------------------|-----------------------|
| Product Line | Cablofil | Finish | Hot Dipped Galvanized |
| UPC Number | 800388532045 | Country Of Origin | Mexico |

Dimensions

| | | | |
|-------------------|-------------|-------------------|----------|
| Product Width US | 3.3 in | Product Weight US | 0.911 lb |
| Product Volume US | 0.143 cu ft | Product Depth US | 10.0 in |
| Product Height US | 7.5 in | | |

Buy American Act Compliance

| | |
|-----|-----|
| BAA | Yes |
|-----|-----|