

Catalog Number • Numéro de Catalogue • Número de Catálogo: RT-200

Country of Origin: Made in China • Pays d'origine: Fabriqué en Chine • País de origen: Hecho en China

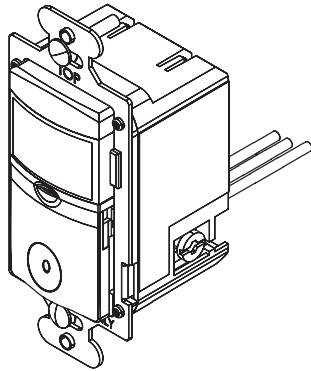

SPECIFICATIONS

Voltage	120/277VAC, 50/60Hz
Load (Single Pole).....	0-800W tungsten or ballast, 1/6HP
Environment	Indoor Use Only
Operating Temperature	32° to 122° F (0° to 50° C)
Humidity	95% RH, non-condensing
Countdown Options.....	none, 5 min, 10 min, 15 min, 30 min,1 hr, 2 hr (default), 3hr, 4 hr, 5 hr, or 6hr
Tools Needed	
Insulated Screwdriver	
Wire Strippers	

DESCRIPTION AND OPERATION

The RT-200 is an astronomic time clock and timer switch that controls the connected light or fan either manually or through user programmed times.

Upon installation the user enters the correct longitude/latitude coordinates, date, and local time. This ensures that once the schedules are programmed, the load turns ON/OFF at the correct local times. The button switch is a customizable manual override feature with a default countdown of 2 hours.

Lighted Switch

To help locate the switch button in a dark room, an amber LED illuminates the ON/OFF button while the controlled load is OFF. When the load is ON, the LED is OFF.



WARNING



**DISCONNECT POWER AT THE CIRCUIT BREAKER BEFORE INSTALLING THIS PRODUCT.
ONLY CONNECT THE RT-200 TO A SINGLE POLE CIRCUIT. THE RT-200 IS NOT SUITABLE FOR 3-WAY SWITCHING.
IF THE EXISTING WIRING DOES NOT MATCH THE DESCRIPTION FOR A SINGLE POLE
CIRCUIT, YOU SHOULD CONSULT WITH A QUALIFIED ELECTRICIAN.**

INSTALLATION & WIRING

- 1. Prepare the switch box**
After the power is turned OFF at the circuit breaker box, remove the existing wall plate and mounting screws. Pull the old switch from the wall box.
- 2. Identify the type of circuit**
In a single pole circuit, two single wires connect to two screws on the existing switch. A ground wire may also be present and connected to a ground terminal on the old switch. A neutral wire should also be present in the wall box.
- 3. Prepare the wires**
Tag the wires currently connected to the existing switch, so that they can be identified later. Disconnect the wires. Make sure the insulation is stripped off the wires to expose their copper cores to the length indicated by the "Strip Gauge" (approximately 1/2 inch).

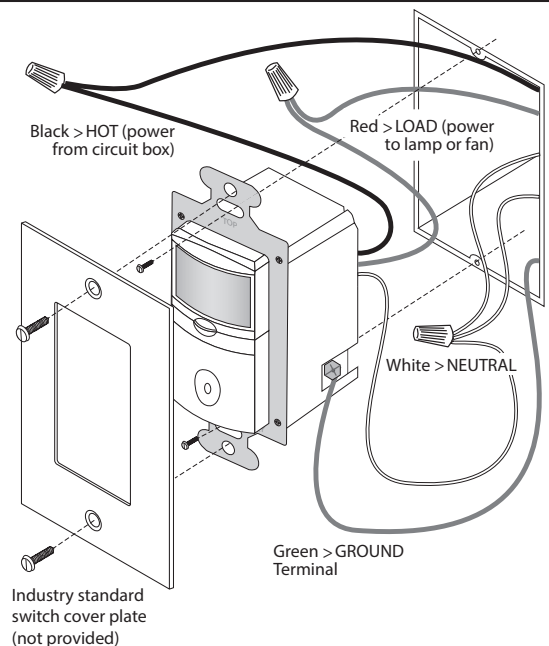
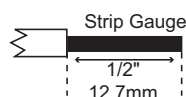

4. Wire the time switch

Twist the existing wires together with the wire leads on the RT-200 as indicated in the table below. Cap them securely using appropriately sized wire nuts.

Power wire from the circuit (hot)	to	Black wire on RT-200
Power wire from the lamp or fan (load)	to	Red wire on RT-200
Neutral wires from the circuit	to	White wire on RT-200
Ground wire from the circuit	to	Ground terminal on RT-200

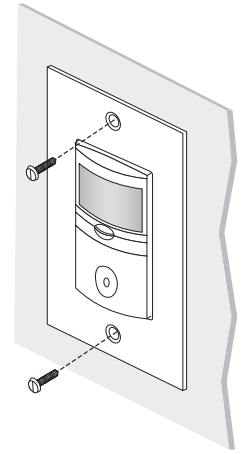

5. Put the RT-200 in the wall box with the display positioned above the ON/OFF button.

Secure it to the wall box with the screws provided.

6. Install cover plates.

Install industry standard decorator wall switch cover plate (not included).

7. Restore power to the circuit.

Turn on the breaker or replace the fuse.

SETUP

To access the programming buttons, place the tip of a flat head screwdriver behind the lip at the top of the **ON/OFF** button and pull the button toward you. Slide the **ON/OFF** button down over the wallplate.

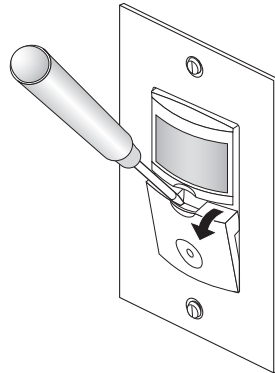

Buttons

The three programming buttons are used to set up the astronomic time switch according to the user's preferences and location.

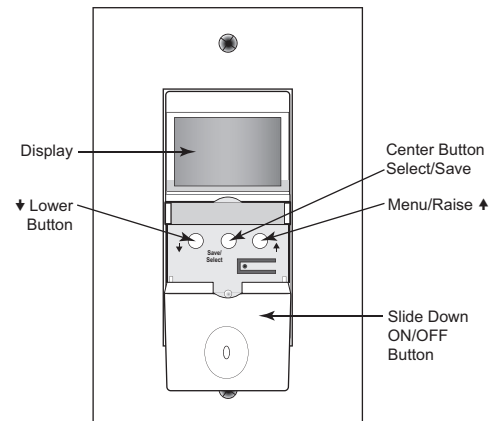

RT-200 Menu Options

Once in the **SETUP** menu if there is no activity for 10 minutes, the unit automatically exits out to the **MAIN PAGE**.

From the standard display, known as the **"MAIN PAGE"** press and release the **↑** button to enter **SETUP** menu.

Press the **↓** button to move to desired **SETUP** menu option.

When the option that you want to program is highlighted, press the **center** button.

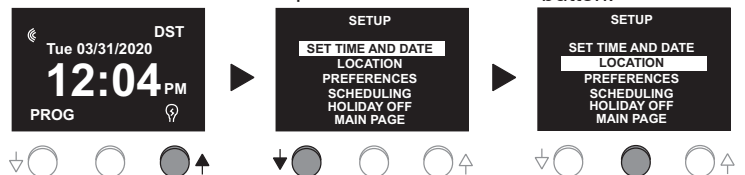

VIEWING SETTINGS

Once the RT-200 has been completely set up, it is possible to see the various programs without needing to enter the **SETUP** menu. From the **MAIN PAGE** press and hold the **ON/OFF** button. After 5 seconds the display changes to show the sunrise and sunset time. Continue to press and hold the **ON/OFF** button. The display will cycle through the 8 programs. Once the RT-200 has completed this cycle, it will continue to cycle through the programs as long as the button is being pressed.

MANUAL-ON

When the lights are turned **ON** manually, the word **MANUAL** appears on the bottom left corner of the display (replacing **PROG**). The default manual override time of the switch is 2 hours, and can be programmed to a countdown of NONE, 5, 10, 15 minutes or 1-6 hours. For example, if the countdown timer was scheduled to 2 hours, a load was scheduled to turn OFF at 10:00 PM, and a user turns the load ON at 10:15 PM, the lights will remain ON until 12:15 AM. If the load was scheduled to turn ON at 6:00 AM and the load is manually turned OFF at 9:30 AM, the load will remain OFF until 6:00 AM the following day or until manually turned ON.

When the load is ON the light bulb on the lower right corner of the display on the **MAIN PAGE** will have light beams surrounding it. When the connected load is OFF, the light beams will disappear.

POWER FAILURE

In the event of a loss of power to the RT-200, the unit will maintain the correct time, location and settings for 72 hours.

SET TIME AND DATE MENU

Within the **SET TIME AND DATE** menu you will enter the correct time, date and Daylight Savings Time (DST) start and end days. The unit is shipped with the correct DST start and end dates already programmed.

Setting	Steps
TIME	
Hour	<ol style="list-style-type: none"> 1. From the SETUP menu highlight SET TIME AND DATE and press the center button. TIME should be highlighted. 2. Press the center button to highlight hour. 3. Press the ↓ button to decrease the hour or the ↑ button to increase the hour. 4. Press the center button to save hour setting and move highlighted cursor to minute.
Minute	<ol style="list-style-type: none"> 1. Press the ↓ button to decrease the minute or the ↑ button to increase the minute. 2. Press the center button to save time setting.
DATE	1. Press the ↓ button to highlight DATE .
Month	<ol style="list-style-type: none"> 1. Press the center button to highlight month. 2. Press the ↓ button to decrease the month or the ↑ button to increase the month. 3. Press the center button to save month setting and move highlighted cursor to day.
Day	<ol style="list-style-type: none"> 1. Press the ↓ button to decrease the day or the ↑ button to increase the day. 2. Press the center button to save day setting and move highlighted cursor to year.
Year	<ol style="list-style-type: none"> 1. Press the ↓ button to decrease the year or the ↑ button to increase the year. 2. Press the center button to save year setting.
DST (DAYLIGHT SAVINGS TIME)	<p>Factory Default Setting: DST ENABLED (The unit will automatically adjust for Daylight Savings Time).</p> <p>Press the ↓ button to highlight DST</p>
DST When enabled, DST appears in the upper right corner of the MAIN PAGE.	<ol style="list-style-type: none"> 1. Press the center button to highlight ENABLED. 2. Press the ↑ button to switch between ENABLED and DISABLED. 3. Press the center button to save DST setting.
Start - Week (Input week when DST starts)	<ol style="list-style-type: none"> 1. Press the ↓ button to highlight START. Press the center button to highlight 1st. 2. Press the ↓ button to decrease the week of the month or the ↑ button to increase the week of the month. 3. Press the center button to save the week and move highlighted cursor to the month.
Start – Month (Input month when DST starts)	<ol style="list-style-type: none"> 1. Press the ↓ button to decrease the start month or the ↑ button to increase the start month. 2. Press the center button to save month.
End – Week	<ol style="list-style-type: none"> 1. Press the ↓ to highlight End. 2. Follow same steps for Start – Week.
End – Month	Follow same steps for Start - Month.

To exit **SET TIME AND DATE** menu, press the ↓ button to highlight **PREVIOUS** menu. Press the **center** button to select and return to the **SETUP** menu.

LOCATION MENU

Within the **LOCATION** menu you will be required to enter the local longitude/latitude coordinates and time zone. If you do not know this information, we have included a list of the major US cities on page 5. You can also find latitude and longitude lookup tools on the internet. One example is www.latlong.net.

Setting	Steps
TIME ZONE	<ol style="list-style-type: none"> 1. From the SETUP menu highlight LOCATION and press the center button. TIME ZONE should be highlighted. 2. Press the center button to select the time zone. 3. Press the ↓ button to decrease the time zone or the ↑ button to increase the time zone. 4. Press the center button to save time zone setting.
LONGITUDE	<ol style="list-style-type: none"> 1. Press the ↓ button to highlight LONGITUDE. 2. Press the center button to select the longitude 3. Press the ↓ button to decrease the longitude or the ↑ button to longitude the time zone. 4. Press the center button to save longitude setting.
LATITUDE	<ol style="list-style-type: none"> 1. Press the ↓ button to highlight LATITUDE. 2. Press the center button to select the latitude. 3. Press the ↓ button to decrease the latitude or the ↑ button to latitude the time zone. 4. Press the center button to save latitude setting.

To exit the **LOCATION** menu, press the ↓ button to highlight **PREVIOUS MENU**. Press the **center** button to select and return to the **SETUP** menu. Once the location information is entered, return to the **MAIN PAGE** and press the left button. This will display the sunrise and sunset times. Use this as a check to validate that the location information has been entered in correctly.

COVER PLATES

Wattstopper RT wall switches fit behind industry standard decorator style switch cover plates.

TROUBLESHOOTING

Lighted switch is **OFF**, no load response to **ON/OFF** button press:

- Make certain that the circuit breaker is on and functioning.

Lighted switch is **ON**, no load response to **ON/OFF** button press:



- Check the light bulb and/or motor switch on the fan mechanism.

NOTE: If load does not respond properly after following troubleshooting, turn OFF power to the circuit then check wire connections or call technical support.

PREFERENCES

The **PREFERENCES** menu allows the user to customize the unit's features including the time/date format, sound and flash.

- **Time format** – choose between a 12-hour or 24-hour format
- **Date format** – choose between **MM/DD/YY** or **DD-MM-YY**
- **Sound** – When **SOUND** is enabled the RT-200 will beep every 5 seconds when the load is going to be turned OFF in less than a minute. It will also beep each time the user presses the ↑, the **center**, or the ↓ button. A small ear icon will appear on the **MAIN PAGE** when sound is enabled.
- **Flash** – When **FLASH** is enabled the RT-200 turns OFF the load for 1 second and then turns it back ON to warn the user that the load is turning OFF in 1 minute. When flash is enabled, a lightening bolt icon will appear on the **MAIN PAGE**.
- **Countdown** – When **COUNTDOWN** is enabled, the manual override to turn a load ON times out. Default countdown of manual override is 2 hours, but this can be adjusted or disabled. Available values: None, 5 min, 10 min, 15 min, 30 min, 1 hr, 2 hr, 3hr, 4 hr, 5 hr, or 6 hr.

Setting	Steps
TIME FORMAT	<ol style="list-style-type: none"> 1. From the SETUP menu highlight PREFERENCES and press the center button. TIME FMT should be highlighted. 2. Press the center button to select time format. 3. Press the ↑ button to change format. 4. Press the center button to save time format setting and to move highlighted cursor back to TIME FMT.
DATE FORMAT	<ol style="list-style-type: none"> 1. Press the ↓ button to highlight DATE FMT. Press the center button to select date format. 2. Press the ↑ button to change format. 3. Press the center button to save date format.
SOUND 	<ol style="list-style-type: none"> 1. Press the ↓ button to highlight SOUND. Press the center button to select the sound setting. 2. Press the ↑ button to enable or disable sound. 3. Press the center button to save setting.
FLASH 	<ol style="list-style-type: none"> 1. Press the ↓ button to highlight FLASH. Press the center button to select the flash setting. 2. Press the ↑ button to enable or disable flash. 3. Press the center button to save setting.
COUNTDOWN	<ol style="list-style-type: none"> 1. Press the ↓ button to highlight COUNTDOWN. Press the center button to select the countdown setting. 2. Press the ↑ button or ↓ button to select the countdown time. 3. Press the center button to save setting.

To exit the **PREFERENCES** menu, press the ↓ button to highlight **PREVIOUS MENU**. Press the **center** button to select and return to the **SETUP** menu.

SCHEDULING

The RT-200 has 8 programs allowing the user flexibility in setting schedules to turn the connected load ON/OFF.

Setting	Steps
PROGRAM	<p>From the SETUP menu highlight SCHEDULING and press the center button. PROGRAM should be highlighted.</p> <p>Press the center button to select program #.</p> <p>Press the ↓ button to decrease the program and the ↑ button to increase the program #.</p> <p>Press the center button to save the program #.</p>
Day(s) - Set the days of the week the lights will turn ON for that particular program	<p>Press the ↓ button to highlight DAY(s).</p> <p>Press the center button to select the days when the program will operate.</p> <p>Press the ↑ to choose the day(s); choices include:</p> <p>None (program is not in use).</p> <p>All (program turns ON the connected load every day).</p> <p>Mon – Fri (program turns ON the connected load Monday through Friday).</p> <p>Weekends (program turns ON the connected load Saturday and Sunday).</p> <p>Each individual day of the week (choose the day of the week that the connected load should turn ON).</p> <p>Press the center button to save setting.</p>
ON – Program the time the connected load turns ON	<p>Press the ↓ button to highlight ON. Press the center button to select what time the load will turn on.</p> <p>Press the ↑ to set the ON time; choices include:</p> <p>TIME (program a specific time to turn ON the load).</p> <p>DUSK (program up to 99 minutes before or after dusk for the load to turn ON. Note: this is one of the reasons that it is important that the correct time zone, longitude/latitude coordinates are entered so that the time switch can determine when dawn and dusk will take place).</p> <p>DAWN (program up to 99 minutes before or after dawn for the load to turn ON).</p> <p>Press the center button to save setting.</p>
OFF – Program the time the connected load turns OFF	<p>Press the ↓ button to highlight OFF. Press the center button to select what time the load will turn OFF.</p> <p>Press the ↑ to set the OFF time; choices are the same as for the ON time.</p> <p>Press the center button to save setting.</p>

Follow the same steps to set Programs 1-8.

NOTE: For holidays, set a schedule for each individual day of week, and then change day to "None" for holiday shutoff.

To exit the **SCHEDULING** menu, press the ↓ button to highlight **PREVIOUS** menu. Then press the **center** button to select and return to the **SETUP** menu.

HOLIDAY OFF

The HOLIDAY OFF menu allows the user to set specific dates and duration that loads will be turned Off, There are 16 memory settings, allowing for programming of up to 16 different holidays.

- **Holiday**– Value of 1 through 16.
- **Status**– choose between DISABLED or ENABLED
- **Start Date**– Set the date to begin the HOLIDAY OFF function.
- **Duration** – The number of days the Holiday Off function will be active. Values of 1 though 99, default setting is 1.

Setting	Steps
HOLIDAY	<ol style="list-style-type: none"> 1. From the SETUP menu highlight HOLIDAY OFF and press the center button. HOLIDAY should be highlighted. 2. Press the center button to select the program#. 3. Press the ↑ or ↓ buttons to increase the program #. 4. Press the center button to set the selected program # as the one being edited.
STATUS	<ol style="list-style-type: none"> 1. Press the ↓ button to highlight STATUS. Press the center button to select date format. 2. Press the ↑ button to enable or disable the status. 3. Press the center button to save the status.
START DATE	<ol style="list-style-type: none"> 1. Press the ↓ button to highlight START DATE. Press the center button to select the days, months, and years. 2. Press the ↑ or ↓ buttons to increase or decrease the months, days, or years value. 3. Press the center button to save the date.
DURATION	<ol style="list-style-type: none"> 1. Press the ↓ button to highlight DURATION. Press the center button to select number of days the load will turn OFF beginning when START DATE occurs (provided the STATUS is enabled). 2. Press the ↑ or ↓ buttons to enable or increase or decrease the DURATION value. 3. Press the center button to save setting.

To exit the **PREFERENCES** menu, press the **↓** button to highlight **PREVIOUS MENU**. Press the **center** button to select and return to the **SETUP** menu.

PRODUCT RESET

The RT-200 has a reset button located under the ON/OFF button. If the unit has lost power for an extended period of time (more than 72 hours) and the unit appears to be functioning abnormally (the display is not on or lights are not turning ON/OFF according to the appropriate schedule), it may be necessary to reset the unit. Press and release the reset button. The display will reset so that the Legrand logo appears as it does upon initial power up. At this point, the user will be able to set the date, time and location and reset the programs.

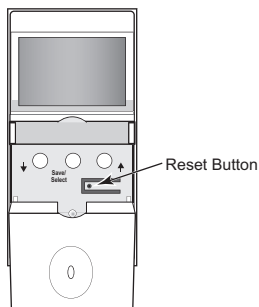

TOP MAJOR US CITY LOCATIONS

CITY, STATE	GMT	LAT	LONG	CITY, STATE	GMT	LAT	LONG
Albuquerque, NM	-7	35	-107	Memphis, TN	-6	35	-90
Arlington, TX	-6	32	-97	Mesa, AZ	-7	33	-111
Atlanta, GA	-5	34	-84	Miami, FL	-5	26	-80
Austin, TX	-6	30	-98	Milwaukee, WI	-6	43	-88
Baltimore, MD	-5	39	-77	Minneapolis, MN	-6	45	-94
Boston, MA	-5	42	-71	Nashville, TN	-6	36	-87
Charlotte, NC	-5	35	-81	New Orleans, LA	-6	30	-90
Chicago, IL	-6	42	-88	New York, NY	-5	41	-74
Cleveland, OH	-5	41	-82	Oakland, CA	-8	38	-122
Colorado Springs, CO	-7	38	-104	Oklahoma City, OK	-6	35	-98
Columbus, OH	-5	40	-83	Omaha, NE	-6	41	-96
Dallas, TX	-6	33	-97	Philadelphia, PA	-5	40	-75
Denver, CO	-7	40	-105	Phoenix, AZ	-7	33	-112
Detroit, MI	-5	42	-83	Portland, OR	-8	46	-123
El Paso, TX	-7	32	-106	Raleigh, NC	-5	36	-79
Fort Worth, TX	-6	33	-97	Sacramento, CA	-8	39	-121
Fresno, CA	-8	37	-120	Salt Lake City, UT	-7	41	-112
Honolulu, HI	-10	21	-158	San Antonio, TX	-6	30	-98
Houston, TX	-6	30	-95	San Diego, CA	-8	33	-117
Indianapolis, IN	-5	40	-86	San Francisco, CA	-8	38	-122
Jacksonville, FL	-5	30	-82	San Jose, CA	-8	37	-122
Kansas City, MO	-6	39	-95	Seattle, WA	-8	47	-122
Las Vegas, NV	-8	36	-115	Tucson, AZ	-7	32	-111
Long Beach, CA	-8	34	-118	Tulsa, OK	-6	36	-96
Louisville, KY	-5	38	-86	Virginia Beach, VA	-5	36	-75
Los Angeles, CA	-8	34	-118	Washington, DC	-5	39	-77

NAVIGATION, USER OPTIONS & PROGRAMMING

RT-200 Menu Options

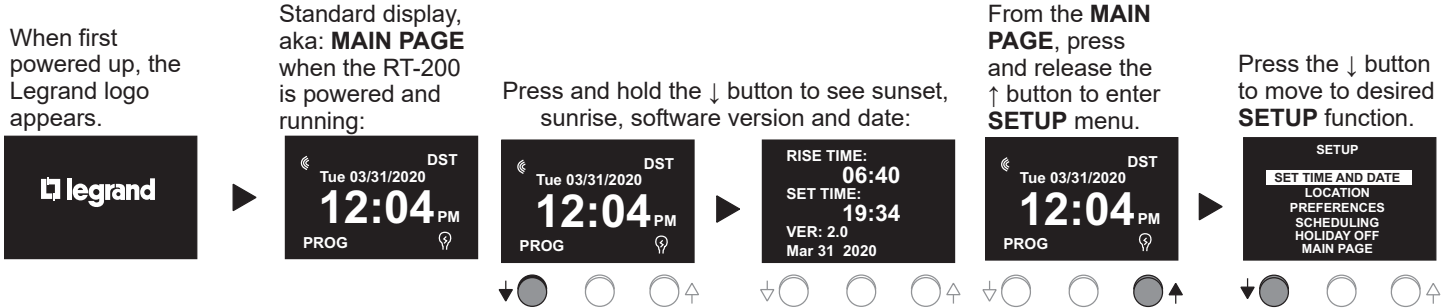

NOTE: Once in **SETUP** menu, the ↓ button moves to the previous menu or decreases the value, the ↑ button moves to next menu or increases the value. The **center** button confirms the selected variable.

SET TIME AND DATE

Setting the TIME

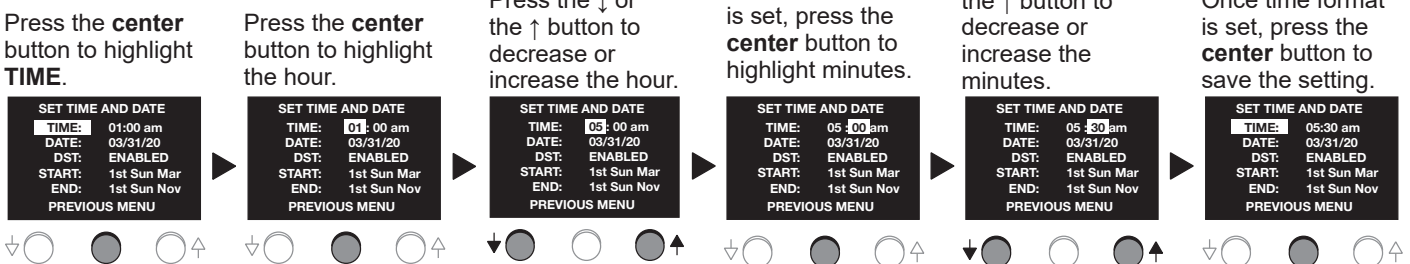

Setting the DATE

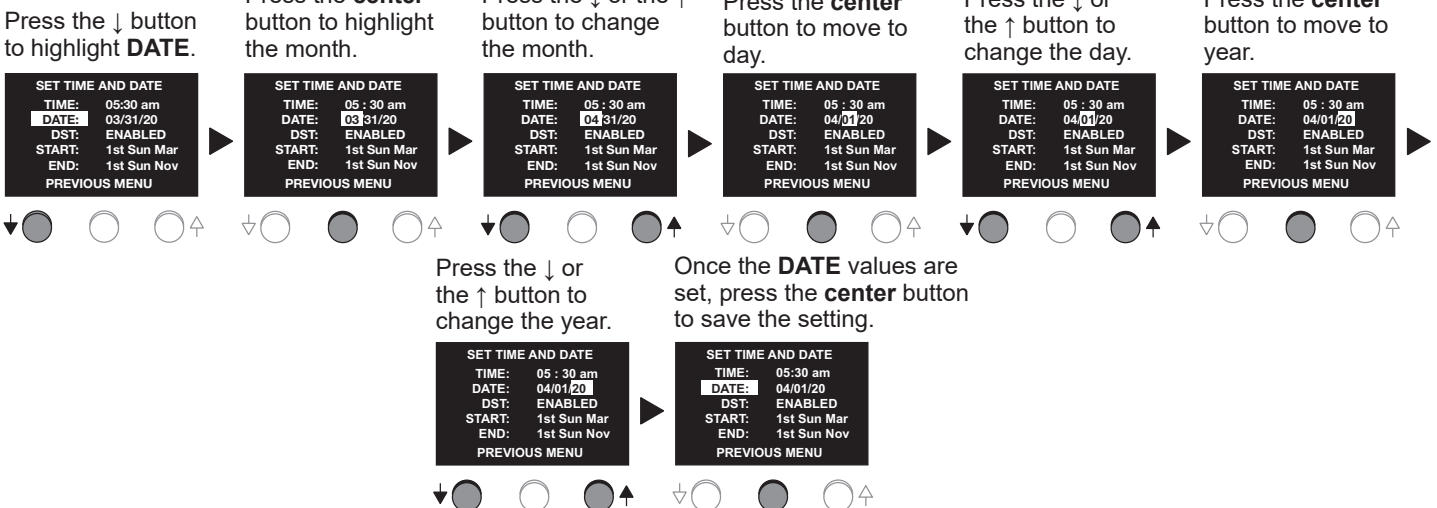

Setting the DST (Daylight Savings Time)

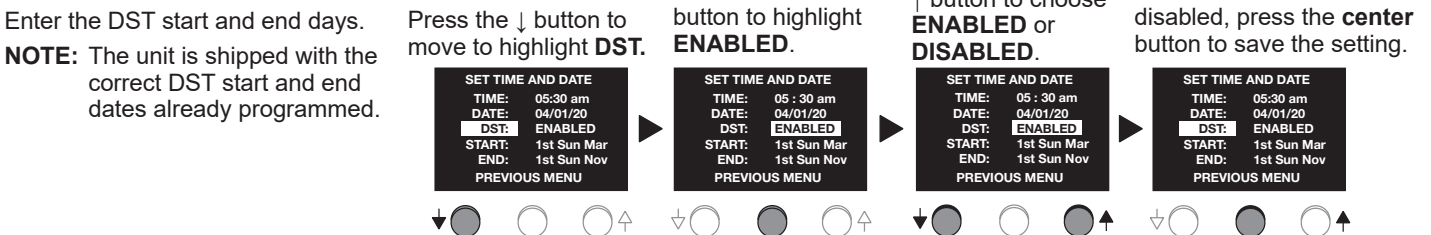

Setting the DST START DATE

Press the ↓ button to move to highlight **START**.

Press the **center** button to move to Week in the month.

Press the ↓ or the ↑ button to choose the week.

Once the week is selected, Press the **center** button to highlight month.

Press the ↓ or the ↑ button to choose the month.

Once the month is set, press the **center** button to save the setting.

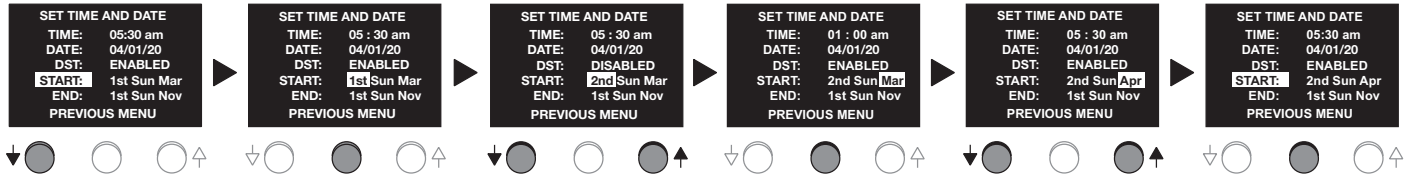

Setting the DST END DATE

Repeat the same process as setting the DST start date for setting the DST end date. Once the DST end date is set, press the ↓ button to highlight **PREVIOUS** menu. Press **center** button to return to the **SETUP** menu.

Location

Within the **LOCATION** menu you will be required to enter the local longitude/latitude coordinates and time zone. See pages 4 and 5 for details on finding latitude and longitude.

Setting the TIME ZONE

Press the ↓ button to highlight **LOCATION**.

Press the **center** button to highlight **TIME ZONE**.

Press the **center** button to highlight time zone values.

Press the ↓ or the ↑ button to decrease or increase the value.

Once time zone is set, press the **center** button to save the setting.

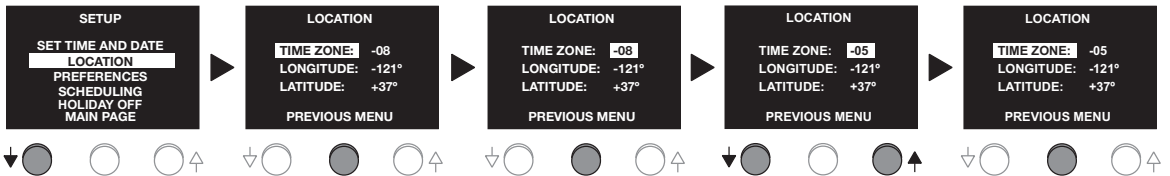

Setting the LONGITUDE

Press the ↓ button to highlight **LONGITUDE**.

Press the **center** button to highlight Longitude values.

Press the ↓ or the ↑ button to decrease or increase the value.

Once Longitude is set, press the **center** button to save the setting.

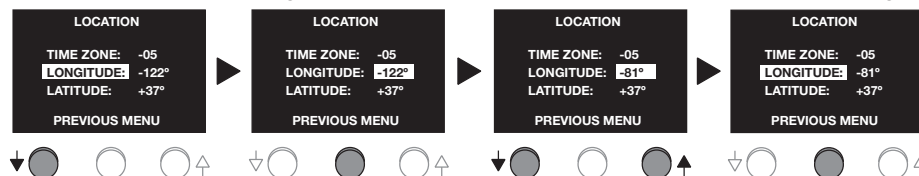

Setting the LATITUDE

Press the ↓ button to highlight **LATITUDE**.

Press the **center** button to highlight Latitude values.

Press the ↓ or the ↑ button to decrease or increase the value.

Once Latitude is set, press the **center** button to save the setting.

Press the ↓ button to highlight **PREVIOUS MENU**.

Once **PREVIOUS** menu is highlighted press the **center** button to return to **SETUP** menu.

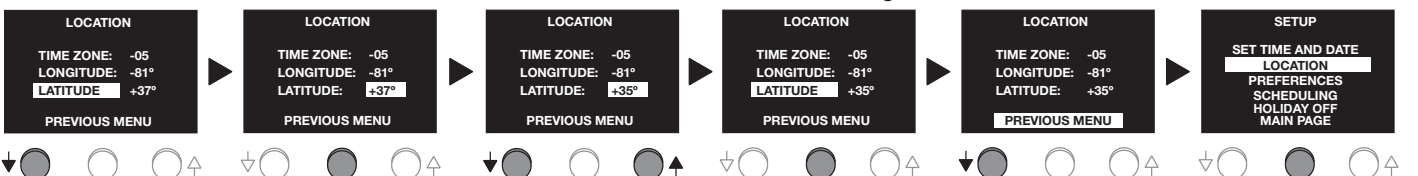

Preferences

Setting the TIME FORMAT

Press the ↓ button to highlight **PREFERENCES**.

Press the **center** button to highlight **TIME FMT**.

Press the **center** button to highlight the time setting.

Press the ↓ or the ↑ button to switch between 12 hours and 24 hours.

Once time format is set, press the **center** button to save the setting.

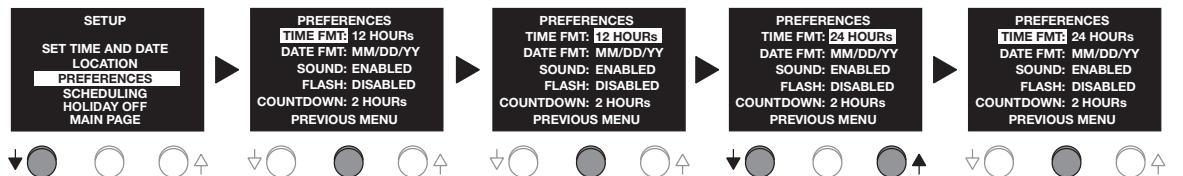

Setting the DATE FORMAT

Press the ↓ button to highlight **DATE FMT.**

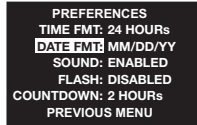

Press the **center** button to highlight date setting.

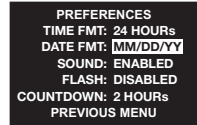

Press the ↓ or the ↑ button to choose the date setting. (MM/DD/YY or DD/MM/YY)

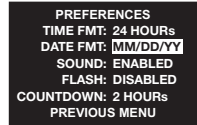

Once date format is set, press the **center** button to save the setting.

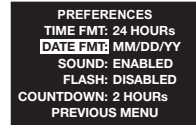

Setting the SOUND

Press the ↓ button to highlight **SOUND.**

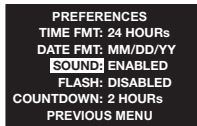

Press the **center** button to highlight **ENABLED.**

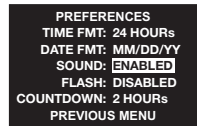

Press the ↓ or the ↑ button to choose **ENABLED** or **DISABLED.**

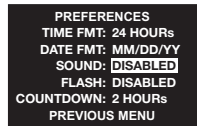

Once sound preference is set, press the **center** button to save the setting.

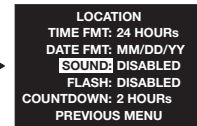

Setting the FLASH

Press the ↓ button to highlight **FLASH.**

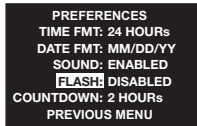

Press the **center** button to highlight **DISABLED.**

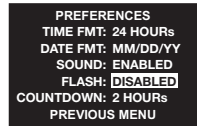

Press the ↓ or the ↑ button to choose **ENABLED** or **DISABLED.**

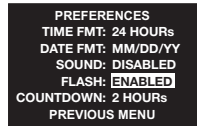

Once flash preference is set, press the **center** button to save the setting.

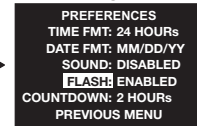

Setting the COUNTDOWN

Press the ↓ button to highlight **COUNTDOWN.**

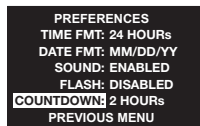

Press the **center** button to highlight **2 HOURS.**

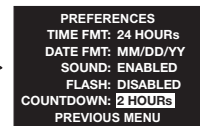

Press the ↓ or the ↑ button to choose a countdown value.

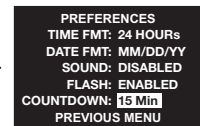

Once countdown value is set, press the **center** button to save the setting.

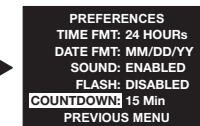

Press the ↓ button to highlight **PREVIOUS MENU.**

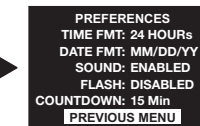

Once **PREVIOUS MENU** is highlighted press the **center** button to return to **SETUP** menu.

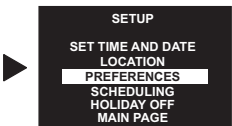

Schedule

Setting the PROGRAM

There are 8 different programs that can be set.

Press the ↓ button to highlight **SCHEDULING.**

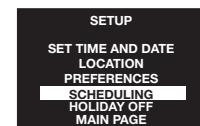

Press the **center** button to enter the **PROGRAM** menu.

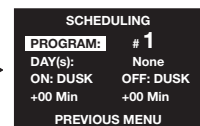

Press the **center** button to highlight the program #.

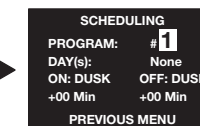

Press the ↓ or the ↑ button to decrease or increase program #.

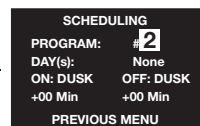

Once the program is set, press the **center** button to save and edit the program.

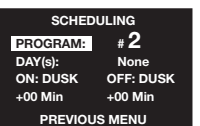

Setting the DAY(s)

This refers to the days of the week when the program will be initiated.

Options include:

None, All, Mon – Fri, Weekends, Sun, Mon, Tue, Wed, Thu, Fri, Sat.

Press the ↓ button to highlight **DAY(s)**

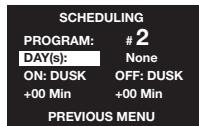

Press the **center** button to highlight the day(s) options.

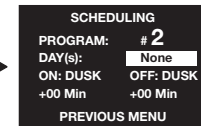

Press the ↓ or the ↑ button to choose the day(s) options.

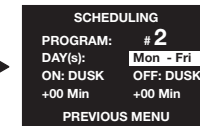

Press **center** button to save the setting.

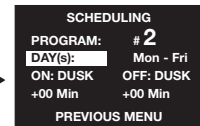

Setting ON/OFF

This sets when the program will come on. The options for this setting are **DUSK**, **DAWN**, or **TIME**. The **DAWN** or **DUSK** option will program the number of minutes before or after dawn or dusk that program should take effect. Dusk and Dawn are based on the **Longitude** and **Latitude** settings. If you choose Time, then the time parameters are enabled.

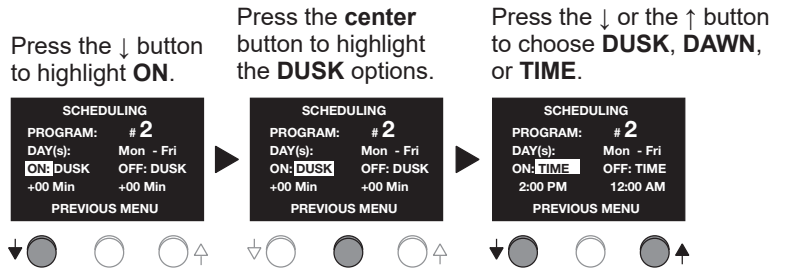

To set the time:

Press the **center** button to highlight the hour.

Press the ↓ or the ↑ button to decrease or increase the hour

Press the **center** button to move to the minutes.

Press the ↓ or the ↑ button to decrease or increase the minutes

Once the time is set, press the **center** button to save the setting.

Press the ↓ button to move to **OFF**.

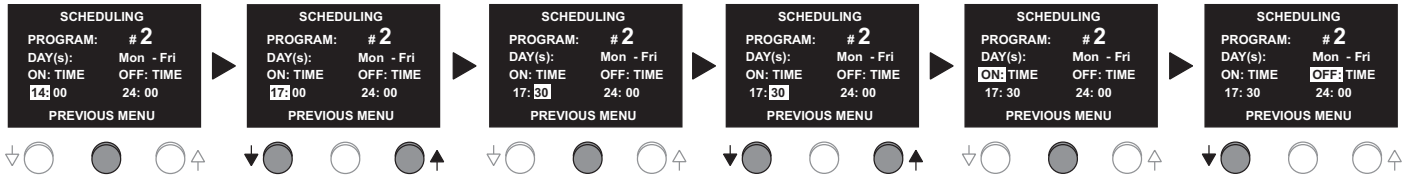

Follow the same steps for setting the **OFF** options as you did for setting the **ON** options. The same process is used for setting the **DAWN** and **DUSK** options that was used for setting the **TIME** option. Once the DST end date is set, press the ↓ button to highlight **PREVIOUS** menu. Press **center** button to return to the **SETUP** menu.

Holiday Off

Setting the HOLIDAY

There are 16 different memory locations for specifying holidays in which the loads will be turned Off.

Press the ↓ button to highlight **HOLIDAY OFF**.

Press the **center** button to enter the **HOLIDAY** menu.

Press the **center** button to highlight the holiday #.

Press the ↓ or the ↑ button to decrease or increase holiday #.

Once the program is set, press the **center** button to save and edit the holiday.

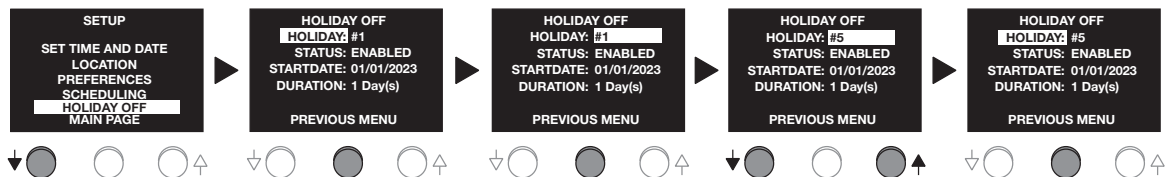

Setting the STATUS

Each Holiday location can be enabled or disabled. If disabled, the memory location will retain the Date and duration settings but will not turn off the loads.

Press the ↓ button to highlight **STATUS**

Press the **center** button to highlight the status options.

Press the ↓ or the ↑ button to choose the status options.

Press **center** button to save the setting.

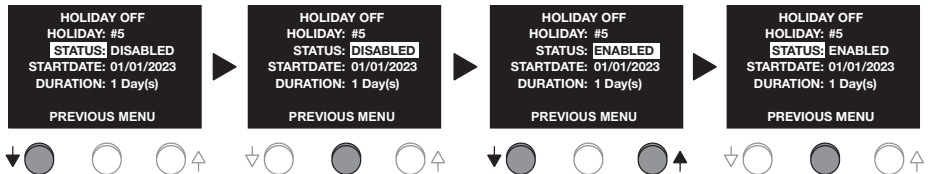

Setting the START DATE

Press the ↓ button to highlight **STARTDATE**.

Press the **center** button to highlight the month.

Press the ↓ or the ↑ button to change the month.

Press the **center** button to move to day.

Press the ↓ or the ↑ button to change the day.

Press the **center** button to move to year.

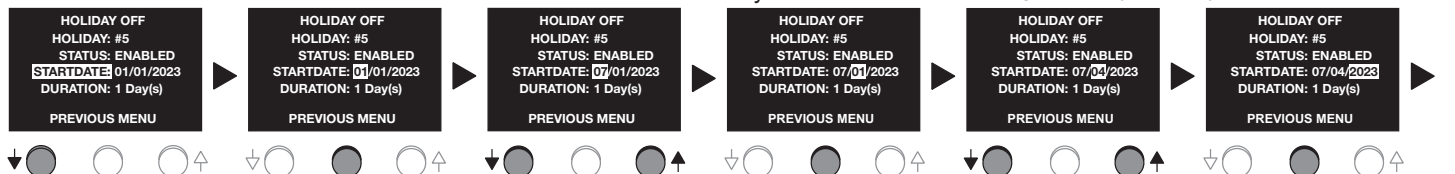

Press the ↓ or the ↑ button to change the year.

Once the **STARTDATE** values are set, press the **center** button to save the setting.

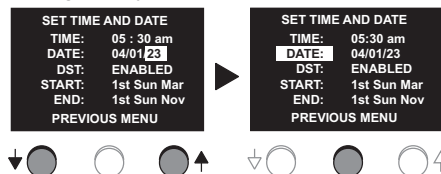

Setting the DURATION

Select the number of days the holiday will last.

Press the ↓ button to highlight **STATUS**

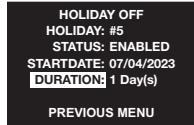

Press the **center** button to highlight the status options.

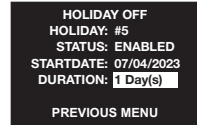

Press the ↓ or the ↑ button to choose the status options.

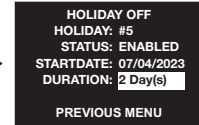

Press **center** button to save the setting.

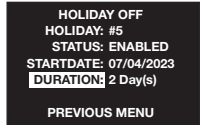

Navigating Back to the MAIN PAGE

Press the ↓ button to highlight **PREVIOUS MENU**.

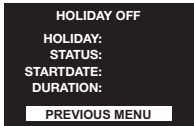

Press the **center** button to return to **SETUP** menu.

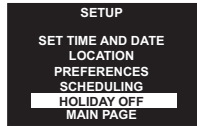

Press the ↓ button to highlight **MAIN PAGE**.



Press the **center** button to return to the **MAIN PAGE**.

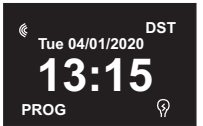

WARRANTY INFORMATION

Wattstopper warrants its products to be free of defects in materials and workmanship for a period of five (5) years. There are no obligations or liabilities on the part of Wattstopper for consequential damages arising out of, or in connection with, the use or performance of this product or other indirect damages with respect to loss of property, revenue or profit, or cost of removal, installation or reinstallation.

INFORMATIONS RELATIVES À LA GARANTIE

Wattstopper garantit que ses produits sont exempts de défauts de matériaux et de fabrication pour une période de cinq (5) ans. Wattstopper ne peut être tenu responsable de tout dommage consécutif causé par ou lié à l'utilisation ou à la performance de ce produit ou tout autre dommage indirect lié à la perte de propriété, de revenus, ou de profits, ou aux coûts d'enlèvement, d'installation ou de réinstallation.

INFORMACIÓN DE LA GARANTÍA

Wattstopper garantiza que sus productos están libres de defectos en materiales y mano de obra por un período de cinco (5) años. No existen obligaciones ni responsabilidades por parte de Wattstopper por daños consecuentes que se deriven o estén relacionados con el uso o el rendimiento de este producto u otros daños indirectos con respecto a la pérdida de propiedad, renta o ganancias, o al costo de extracción, instalación o reinstalación.